

INSTALLATION & OPERATING INSTRUCTIONS FOR

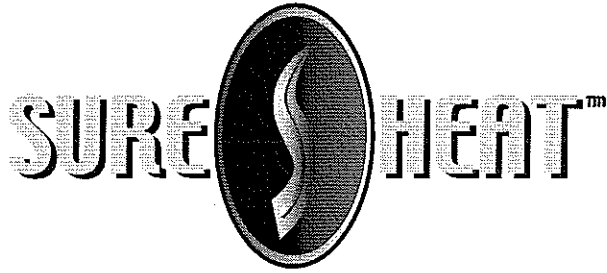

FIREPLACE GAS LOGS

Applicable for use with all styles and sizes of Dual Burner Natural Gas Log Sets.
Note: Installer should leave these instructions with the consumer to retain for future reference.

TIERED DUAL BURNER



Sure Heat Manufacturing

1861 West Oak Parkway

Marietta, GA 30062

Tel: (770) 422-8008

Fax: (770) 693-8076

Please Read these instructions carefully before you begin to install this gas log set.

FOR YOUR SAFETY

- If you smell gas:
 1. Open windows
 2. Don't touch electrical switches
 3. Extinguish any open flame
 4. Immediately call your gas supplier.
- Do not store or use gasoline or flammable vapors and liquids in the vicinity of this or any other appliance.
- Do not place clothing or other flammable material on or near the appliance.
- Children and adults should be alerted to the hazards of high surface temperature and should stay away to avoid burns or clothing ignition.
- Young children should be carefully supervised when they are in the same room as the appliance.

DUAL BURNER PARTS LIST

Figure 1



1-6

GRANULES
(HEAVY WEIGHT BAG)

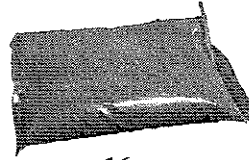

16

GLOWING EMBERS
(LIGHT WEIGHT BAG)

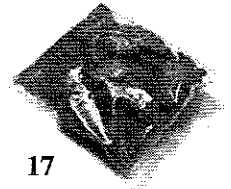

17

Number of logs are determined by the size and model chosen.
Sets range from 4 to 9 logs.

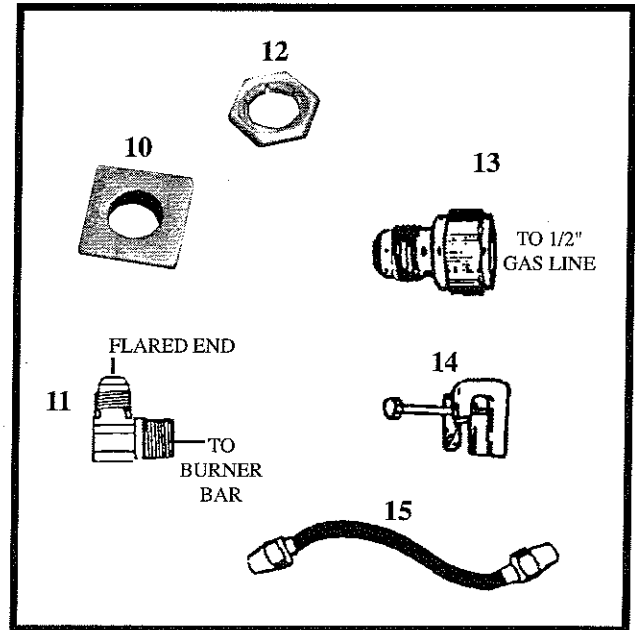
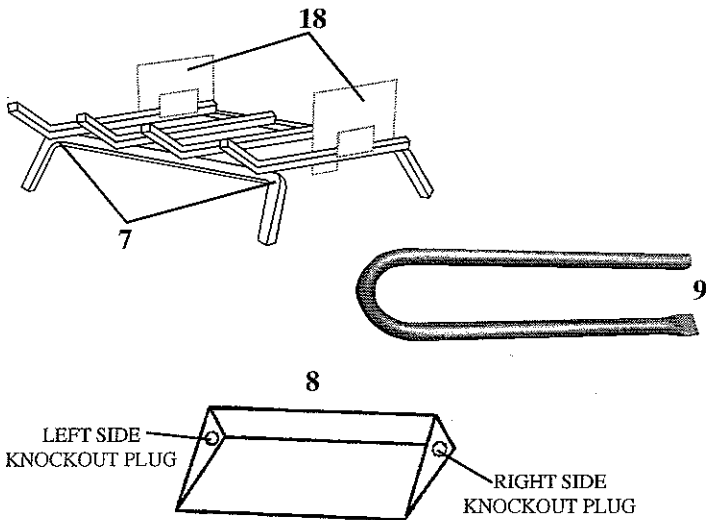

REF.	DUAL BURNER RADCO	PART NUMBER 18" SET	QTY	PART NUMBER 24" SET	QTY	PART NUMBER 30" SET	QTY
1-6	Logs	—	—	—	—	—	—
7	Grate	WIP-200-90556	1	WIP-200-90566	1	WIP-200-90680	1
8	Burner Pan	WIP-200-90502	1	WIP-200-90504	1	WIP-200-90506	1
9	Dual Burner Bar	WIP-190-90521	1	WIP-190-90523	1	WIP-190-90525	1
10	3/4" Burner Support Spacer	RMH-120-00420	1	RMH-120-00420	1	RMH-120-00420	1
11	3/8" Brass Orifice Elbow	WIP-120-00350	1	WIP-120-00350	1	WIP-120-0035	1
12	3/8" Locknut	RMH-120-00963	1	RMH-120-00963	1	RMH-120-00963	1
13	3/8" Flared to 1/2" Gas Inlet Fitting	RMH-120-00653	1	RMH-120-00653	1	RMH-120-00653	1
14	Damper Stop Clamp	RMH-120-00100	1	RMH-120-00100	1	RMH-120-00100	1
15	3/8" Flared Tubing	WIP-120-90426	1	WIP-120-90426	1	WIP-120-90426	1
16	Granules	WIP-130-00010	1	WIP-130-00010	1	WIP-130-00010	2
17	Glowing Embers	WIP-130-00300	1	WIP-130-00300	1	WIP-130-00300	2
18	Back Log Standoffs	WIP-190-90560	2	WIP-190-90560	2	WIP-190-90560	2
19	Pipe Sealant	RMH-120-00180	1	RMH-120-00180	1	RMH-120-00180	1
20	Instruction Manual	RMH-130-00588	1	RMH-130-00588	1	RMH-130-00588	1

1. This gas log set is only to be installed and burned in a fully vented fireplace with a fully functional damper and chimney that is free of any obstructions. The fireplace must be constructed of non-combustible materials and approved to burn wood. **WARNING: Do not burn wood or other material in any fireplace fitted with a gas log set.**
2. To operate this gas log set, the fireplace damper must be fully opened and locked.
3. The smallest or minimum dimension of the chimney flue must be 8 inches in diameter. Do not use an Energy Efficient Gas Log Set if it is smaller than 8 inches. Do not use an Energy Efficient Gas Log Set if fumes from the burner emerge into the room when the damper is fully open. This indicates that there is not adequate draft for our log set and the gas log set must not be used until fireplace draft is corrected.
4. This appliance must be installed with a Damper Stop Clamp (Part #14). When operating this gas log set, the flue damper must be fully open.

WARNING: Improper use or installation may cause Carbon Monoxide Poisoning. Carbon Monoxide, which is an odorless and colorless gas, is a by-product of combustion. Caution must be taken to insure the fireplace is properly vented when logs are in use. To avoid having potentially dangerous fumes enter the living area, be sure the chimney is drawing properly and has sufficient draft.

5. A fireplace screen must be in place when operating this gas log set. This screen shall have an opening(s) for the introduction of combustion air. If the fireplace has glass doors, operate this gas set with the doors fully opened.
6. The nominal inlet gas pressure for this appliance is 7" water column for natural gas.
7. This gas log appliance and its individual shutoff valve must be disconnected from the gas supply piping system during any pressure testing at pressures in excess of 1/2 PSIG.

This appliance must also be disconnected from the gas supply system by closing its individual manual shutoff valve during any pressure testing at pressures equal to or less than 1/2 PSIG.

FIREPLACE PREPARATION

- A. Professionally clean chimney and fireplace floor of any combustible material to limit the smell from the system.
- B. Open fireplace damper fully and install Damper Stop Clamp with 1/4 x 2" set screw (Part #14). This clamp is designed to allow any pilot combustion by-products to vent (See Figure 2.) Should the Damper Stop Clamp supplied not fit, a permanent damper stop clamp must be installed that will keep the damper open at a distance of not less than 1 1/2". Damper must be in full open position anytime this unit is in operation.
- C. Prior to connecting the gas log set, make sure that the gas supply to the fireplace is completely shut off.

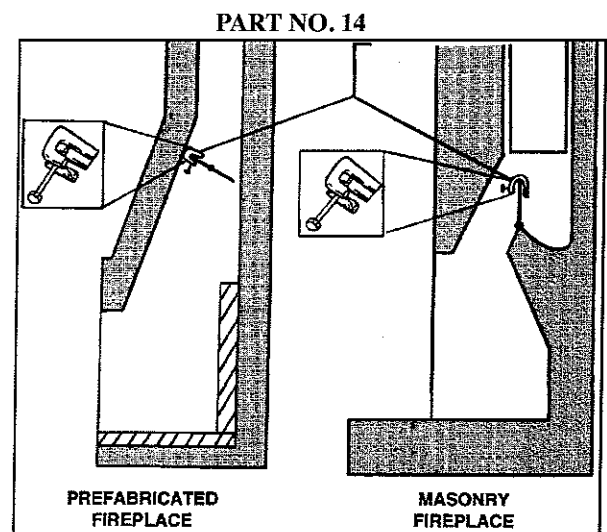

Figure 2. Damper stop clamp

Installation of this Energy Efficient Gas Log Set and provisions for combustion and ventilation air must conform with the National Fuel Gas Code ANSI Z21-84 and applicable local codes.

D. **Prefabricated fireplace:** Refer to the manufacturer's fireplace instruction manual for specific information regarding the running of a gas line into that particular model. A typical prefab installation involves the insertion of a 1/2" gas pipe through the gas line tube provided by each manufacturer from outside the fireplace. The knockout on the inside of the fireplace is removed as the gas pipe is punched through the fireplace.

E. **Masonry fireplaces:** A 1/2" gas supply line must be provided to the firebox. Most installations require drilling an access hole through the masonry wall. The supply line should be secured and sealed by mortar within the access hole. The supply line should also have an on-off valve either in the wall or inside the fireplace. (See Figure 4.)

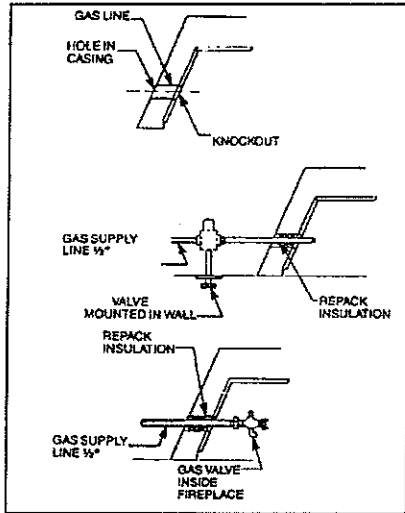

Figure 3 - Gas line installation
Prefabricated fireplace

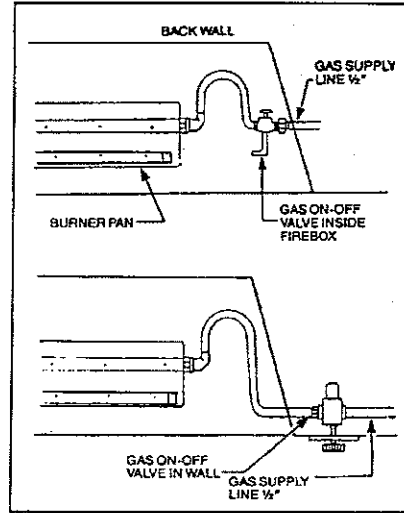

Figure 3 - Gas line installation
Masonry fireplace

GAS LOG INSTALLATION

(See Figure 1 Parts List as a guide to reference part numbers.)

BURNER PAN INSTALLATION

NOTE: Use pipe compound on all male threads to seal joints.

- Determine if the fireplace has a right or left-hand gas line feed. The circular "dimpled" hole covering must be knocked out on the appropriate (right or left) side of the burner pan. **NOTE:** Brace pan on workbench when removing burner knockout. Strike knockout with nailpunch for easy removal.
- Locate 3/8" locknut (Part #12) and fasten it to the 3/8" brass orifice elbow (Part #11). Do not fasten the locknut on the "flared" end.
- Slide the 3/4" burner support spacer (Part #10) over the Dual Burner Bar (Part #9) and move spacer to opposite corner of the gas intake connection (See Figure 5).
- Secure the intake end of the Dual burner bar (Part #9) to the burner pan (Part #8) through the knockout hole selected (right or left hand) with the 3/8" brass orifice elbow (Part #11) and 3/8" locknut previously assembled in Step B (See Figure 6).
- Tighten elbow until firmly attached to the Dual burner bar. Then, firmly tighten the attached locknut on the elbow to seal the burner bar to the wall of the burner pan.

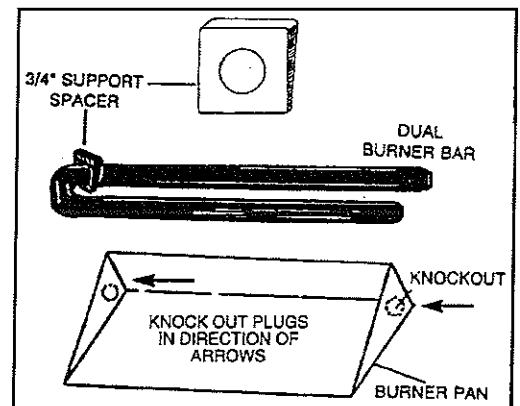

Figure 5 - Burner bar placement

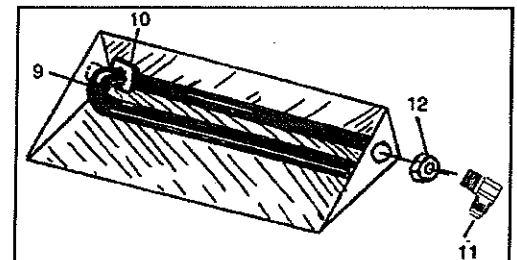

Figure 6 - Burner bar connection

CONNECTING GAS SUPPLY TO BURNER ASSEMBLY

(If a Safety Pilot Kit is to be used, please refer to separate installation instructions.) These instructions refer to Natural Gas applications installed without a Safety Pilot Kit. LP/NG Safety Pilot Kit available at your local store.

- A. Place burner pan assembly in the center of the fireplace.
- B. Attach brass 3/8" Flared to 1/2" gas valve (Part #13) to the 1/2" gas supply stub.
- C. Attach 3/8" flared tubing (part #15) to burner pan assembly. Attach opposite end to gas supply line by carefully bending the flared tubing as needed to make the connection. Avoid kinking the flared tubing while bending. If tubing must be cut, use a tube cutter. Flare the cut end of the tube with a flaring tool.

NOTE: A good method of bending the tube is to fill it with sand, bending the tube as needed to make the connection. This method will eliminate kinking in the line. Once the tube is in the desired configuration for hookup, be sure to **empty** the tube completely of any sand before tube is connected to the gas supply line and the burner.

- D. Be certain all connections are tight and use pipe compound on all male threads to seal joints. Test all connections with a soapy water solution with the gas supply turned on. If bubbles appear on any connection, retighten and retest. Once it is determined there are no leaks whatsoever, turn off gas supply and move to next assembly step.

GRANULE, EMBER AND GRATE PLACEMENT

- A. Spread granules (Part #16) over the installed burner pan. Granules should be sloped to the same angle as the burner pan filling the entire pan. (See Figure 7A).
- B. Spread glowing embers (Part #17) evenly over the top of the granules covering the entire surface area, concentrating on the front and sides of the burner pan for the most realistic burning effect.
- C. Place log grate (Part #7) over the burner pan aligning as shown (See Figure 7B).
- D. Attach back log Standoffs (Part #18) to the back part of the grate (See Figure 7B).

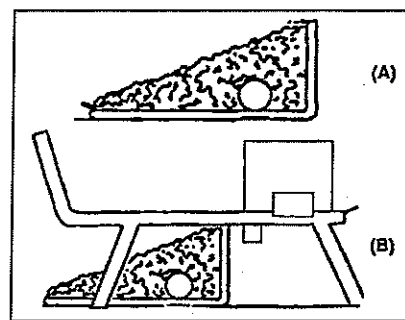

Figure 7 (A & B) -
Granule and Grate Placement

NOTE: A hammer may be used to tap the back log standoffs in place. It may be necessary to squeeze the back log standoffs with pliers after attaching to the grate

LOG PLACEMENT

(Part Numbers 1 through 6)

- A. Place longest log in the front of the grate.
- B. Place the second longest log on the back log standoffs towards the back of the grate. Allow approximately 2" of separation of the bottom logs to allow for proper flame combustion.
- C. Arrange remaining logs on top of the two base logs. Top logs can be rearranged to achieve the desired flame pattern.

LIGHTING YOUR GAS LOG SET

(Manual valve only)

- A. Open chimney flue damper to the full open position.
- B. Be sure gas supply is shut off.
- C. Lay match on top of embers and granules near gas burner input. Do not hold match in hand (See Figure 8).
- D. With match burning, slowly turn on gas.

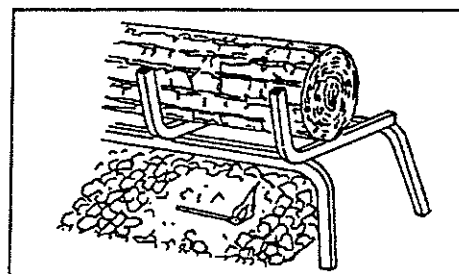
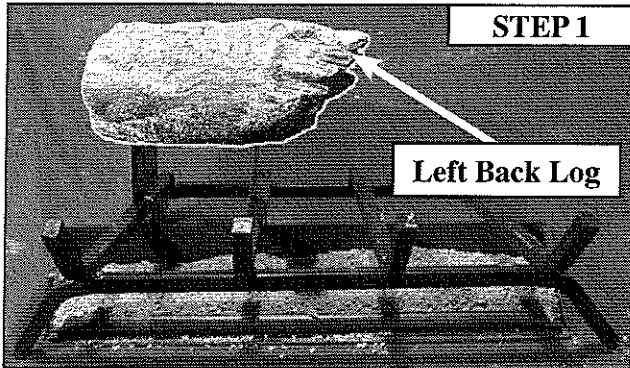

Figure 8- Lighting the log set

LOG PLACEMENT

MODELS: BRO18NG & BRO24NG



Place back log onto the 2 standoffs

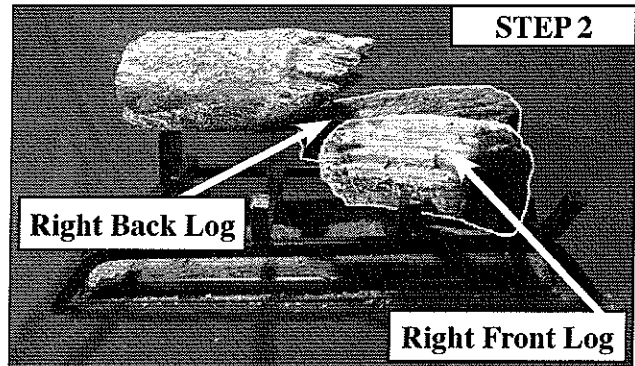

Place right back log and right front log onto grate

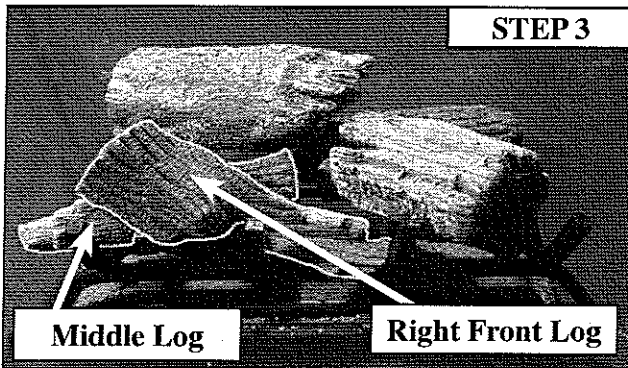

Place the middle log in front of the left back log. Then place the left front log in front of the middle log onto the grate.

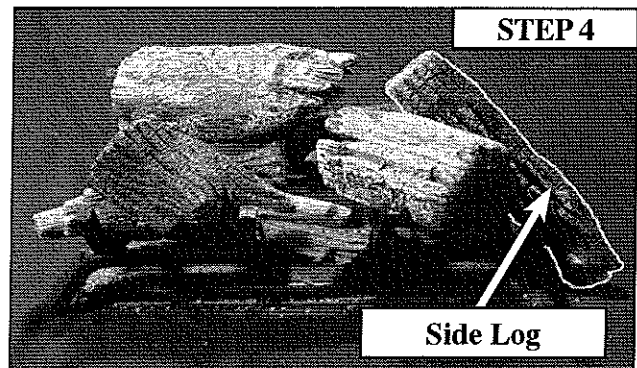

Place the side log in between the right back log and right front log

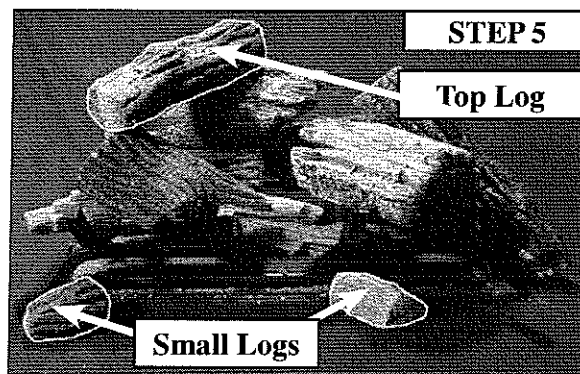

Place the two small logs in front of the grate as shown and the top log on top of the left back log.

NOTE:
MODEL BRO18NG
will only have 7 logs.
It will not contain the
middle log or
one of the small logs.

LOG PLACEMENT

MODELS: CC21NG

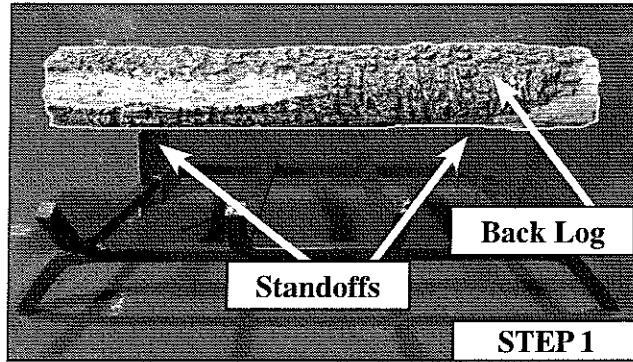

Place back log onto the 2 standoffs.

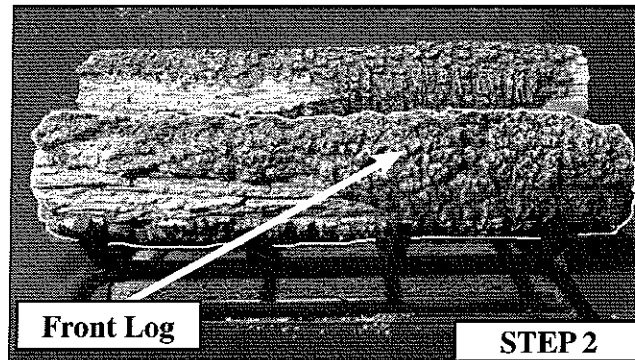

Place front log in front of back log.

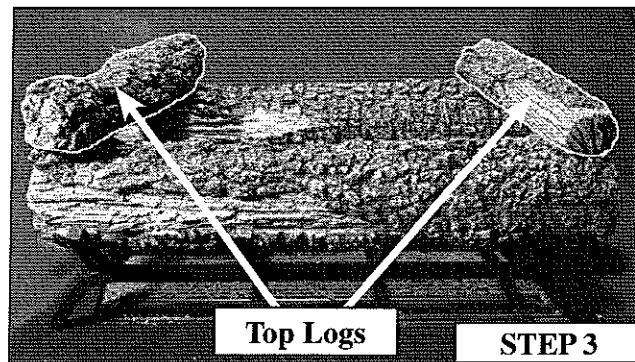

Place top logs on top of back and front logs.

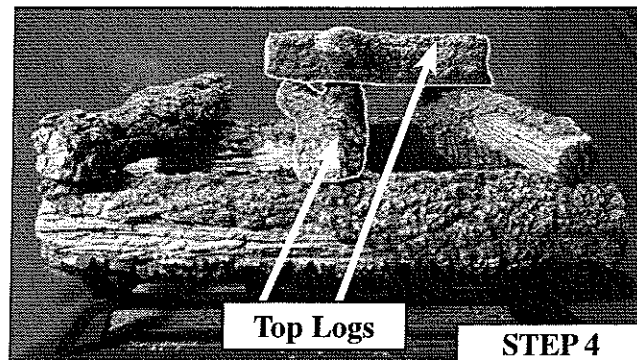

Place remaining top logs as shown above.

MAINTENANCE

Very little maintenance is required. The carbon deposit resulting from combustion is natural and adds to the realistic appearance of the set. If carbon becomes excessive it can be lightly brushed or vacuumed away.

TROUBLE SHOOTING

Problem	Cause	Corrective Action
1. No Ignition	valve not on gas line not clear	turn valve on inspect supply lines for tube kinks or obstructions
2. Inadequate Flame	valve partially closed gas line obstruction log arrangement	open valve fully inspect burner for tube kinks or obstructions rearrange logs to desired pattern

LIMITED WARRANTY

Warranty shall apply to the original purchaser at the original installation point only.

All logs are guaranteed for three years against manufacturer's defects.

The burner assembly system is guaranteed for a period of (3) years from the date of purchase and will be replaced for freight costs only.

Pilot, valves and thermocouples are guaranteed for a period of one (1) year under the original manufacturers warranty.

General Warranty: This warranty does not apply in the case of improper installation, neglect, accident, misuse or as a result of modifications of the original product.

All costs for removal and re-installation are the expressed responsibility of the purchaser.

For repair, replacement, or service to defective part(s) please contact our Customer Service Hotline, number below. Thereafter with valid warranty registration and proof of purchase, call the Customer Service Hotline for authorization to ship defective part prepaid and insured in original carton to Sure Heat Manufacturing, 1861 West Oak Parkway, Marietta, GA 30062. Goods returned improperly packaged are the sole responsibility of purchaser.

It is agreed that any repair or replacement is the exclusive remedy from Sure Heat Manufacturing. In no case shall Sure Heat be liable for any consequential damage or breach of this or any other warranty expressed or implied whatsoever. This limitation as to consequential damages shall not apply in states where prohibited.

Purchased From: _____ Date: _____

Size: 18" 21" 30" Model:

Name: _____ Phone: (____) _____

Address: _____

City: _____ State: _____ Zip: _____

***Please photocopy and return within 14 days of purchase to
Sure Heat, 1861 West Oak Parkway, Marietta, GA 30062***

If you have other questions, please contact the Customer Service Hotline — (800) 229-5647