

SURE HEAT

Installation and Operating Instructions for NATURAL & L.P. GAS VENT FREE UNITS

Model: RVT-18, RVT-24, RVT-30, GVT-18, GVT-24, GVT-30, VFT-18, VFT-24, VFT-30,
CVT-18, CVT-24, CVT-30, SVT-18, SVT-24, SVT-30

DANGER

FAILURE TO FOLLOW THESE INSTRUCTIONS CAREFULLY AND WITHOUT ERROR, OR FAILURE TO HEED ANY AND ALL WARNINGS IN THESE INSTRUCTIONS CAN RESULT IN AN EXPLOSION, FIRE OR THE PRODUCTION OF CARBON MONOXIDE GAS WHICH CAN CAUSE PROPERTY DAMAGE, BODILY INJURY OR DEATH.



Sure Heat Manufacturing

3130 Moon Station Road
Kennesaw, GA 30144
Tel: (770) 422-8008
Fax: (770) 424-3842

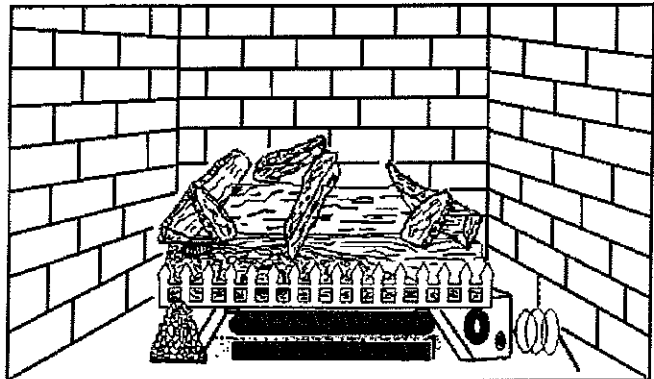

NOTE: THIS UNIT CANNOT BE CONVERTED TO DIFFERENT GAS TYPES.

WARNING: If the information in this manual is not followed exactly, a fire or explosion may result causing property damage, personal injury or loss of life.

- Do not store or use gasoline or other flammable vapors or liquids in the vicinity of this or any other appliance.
- WHAT TO DO IF YOU SMELL GAS:
 - Do not try to light any appliance.
 - Do not touch any electrical switch.
 - Do not use any telephone in your building.
 - Immediately call your gas supplier from a neighbor's telephone.
 - Follow the gas suppliers instructions.
 - If you cannot reach your gas supplier, call the fire department.
- Installation and service must be performed by a qualified installer, service agency or the gas supplier.

This is an unvented gas-fired heater. It uses air (oxygen) from the room in which it is installed. Provisions for adequate combustion and ventilation air must be provided.

THIS APPLIANCE MAY BE INSTALLED IN AN AFTERMARKET MANUFACTURED (MOBILE) HOME, WHERE NOT PROHIBITED BY STATE OR LOCAL CODES. INSTALL ONLY IN A SOLID-FUEL BURNING FIREPLACE OR APPROVED VENTLESS FIREBOX ENCLOSURE (MANUFACTURED UNVENTED FIREPLACE) AS SPECIFIED BY THESE INSTRUCTIONS.

*AFTERMARKET: COMPLETION OF SALE, NOT FOR PURPOSE OF RESALE, FROM THE MANUFACTURER.

THIS APPLIANCE IS ONLY FOR USE WITH THE TYPE OF GAS INDICATED ON THE RATING LABEL ATTACHED TO THE APPLIANCE. THIS APPLIANCE IS NOT CONVERTIBLE FOR USE WITH OTHER GASES.

This appliance is designed as an unvented room heater when installed in a noncombustible fireplace with the flue damper closed.

This appliance may be used as a heating appliance only if unvented heating appliances are permitted by local state and city codes. If unvented heaters are not permitted, then the fireplace vent damper must be locked at the minimum vent area required by local codes, or in the absence of local codes, by the latest edition of the National Fuel Gas Code (ANSI Z223.1 or latest edition).

This installation manual contains valuable safety instructions and installation procedures that should be understood before installation of the unit. The owner of this appliance should keep this instruction manual to refer to in the future. It is the installer's responsibility to instruct the owner of this unit in the proper use and maintenance of this appliance.

DANGER: THIS APPLIANCE, AS ANY GAS-FIRED APPLIANCE, CAN PRODUCE POISONOUS CARBON MONOXIDE ALONG WITH OTHER COMBUSTION PRODUCTS. CARBON MONOXIDE, IN STRONG CONCENTRATIONS, CAN CAUSE SICKNESS, SERIOUS PERSONAL INJURY AND DEATH.

GASEOUS FUELS ARE HIGHLY EXPLOSIVE IN CERTAIN CONCENTRATIONS AND ARE VERY FLAMMABLE. ANY GAS LEAKS IN THE PLUMBING SUPPLYING GAS TO THIS APPLIANCE CAN LEAD TO FIRE OR EXPLOSION.

WHEN PROPERLY INSTALLED, USED AND MAINTAINED, THIS APPLIANCE SHOULD NOT PRODUCE CARBON MONOXIDE IN DANGEROUS QUANTITIES. HOWEVER, SINCE CARBON MONOXIDE CAN BE DEADLY POISONOUS, THE INSTALLER AND ALL USERS OF THIS APPLIANCE SHOULD READ AND FOLLOW THESE INSTRUCTIONS CAREFULLY.

IMPORTANT INFORMATION

Fireplace sizing guide and BTU information:

Set Size	Opening Height	Front Width	Rear Width	Fireplace Depth	BTU Information			
					Natural Gas		L.P. Gas	
					Max.	Min.	Max.	Min.
18"	18"	22"	18"	12"	34,000	22,000	34,000	22,000
24"	18"	28"	23"	15"	40,000	22,000	40,000	22,000
30"	18"	34"	25"	15"	40,000	22,000	40,000	22,000

Sufficient space must be provided around this appliance to provide air for combustion and ventilation. Any alterations to this unit or its controls may be hazardous.

Do not install this heater in bedrooms or bathrooms.

These instructions should be studied carefully before the installation and operation of this unit.

The installation must conform with local codes or, in the absence of local codes, with the National Fuel Gas Code ANSI Z223.1, latest edition.

The installation and repair of this unit should be conducted by a licensed or qualified service person.

WARNING: This appliance is only for installation in a solid fuel burning fireplace made of noncombustible materials or approved ventless firebox enclosure.

This appliance must be kept clear from combustible materials, gasoline or other flammable vapors and liquids.

Solid fuels should not be burned in a fireplace where an unvented room heater is installed.

Keep burner and control compartment clean. See Installation and Operating Instructions accompanying the heater.

Due to high temperatures, the appliance should be located out of traffic and away from furniture and draperies.

Children should be supervised when they are in the same room with the appliance.

All people should be notified of the high surface temperatures of the system to avoid burns or clothing ignition.

This system should be inspected upon installation and annually by a professional service person. It is necessary to keep controls, burner and air passageways clear of any debris.

Do not place any combustible material on or around the appliance.

Do not use this appliance if any part has been submerged under water. Immediately call a qualified service technician to inspect the appliance and to replace any part of the control system and any gas control which has been under water.

This heater shall not be installed in a confined space unless provisions are provided for adequate combustion and ventilation air. The National Fuel Gas Code defines a confined space as a space whose volume is less than 50 cubic feet per 1,000 BTU per hour (4.8m³ per kw) of the aggregate input rating of all appliances installed in that space and an unconfined space as a space whose volume is not less than 50 cubic feet per 1,000 BTU per hour (4.8m³ per kw) of the aggregate input rating of all appliances installed in that space. Rooms communicating directly with the space in which the appliances are installed, through openings not furnished with doors, are considered a part of the unconfined space.

WARNING: If the area in which the heater may be operated is smaller than that defined as an unconfined space, provide adequate combustion and ventilation air by one of the methods described in the National Fuel Gas Code, ANSI Z223.1, 1992, Section 5.3.

This appliance is equipped with an ODS (oxygen depletion sensor) pilot light safety system that turns off the appliance if enough fresh air is not available. Additional ventilation is obtained by opening a door to another room or opening a window.

Always ensure that there is proper ventilation from the area the system is operating in.

Any outside air ducts and/or ash dumps in the fireplace shall be permanently closed at time of appliance installation.

This appliance must be used with glass doors in the OPEN position.

A fireplace screen with an opening for combustion air must be in place when the appliance is operating, unless other provisions for combustion air are provided.

IMPORTANT: During the manufacturing process this appliance is treated with certain coloring agents. These agents are not harmful, but may produce annoying smoke and smell as they are burned off. This is a temporary occurrence that ceases after 4 to 6 hours of use. During the "burning off" period, provide ventilation by opening windows, doors and the chimney flue to allow odors to dissipate. Any remaining odors will burn off with continued use.

WARNING: This appliance cannot be converted to a gas other than the type for which it was made at the factory. Operation of this appliance on gases for which it is not equipped may be hazardous. See identification plate for gas type designation.

Unpacking

Unpack the appliance carefully and inspect for missing parts or damages that may have occurred during shipping. If any part of the appliance is missing or damaged, please notify Sure Heat Manufacturing at (770) 422-8008. An incomplete or damaged appliance may be hazardous. **DO NOT INSTALL A DAMAGED OR INCOMPLETE APPLIANCE.**

Fireplace Preparation

The fireplace needs to be properly prepared before installing this fireplace unit.

1. Turn off gas supply to the fireplace.
2. Clean chimney and fireplace floor of any combustible material to limit the smell from the system.

WARNING: Before installing in a solid fuel burning fireplace, the chimney flue and firebox must be cleaned of soot, creosote, ashes and loose paint by a qualified chimney cleaner.

Unit Placement

Place the entire unit system in the center of the fireplace to allow proper air flow on all sides of the unit.

Gas Piping and Gas Pressure Requirements

Check the type of gas that is supplied to your fireplace. Use only the gas type indicated on the heater's rating plate. If the gas listed on the plate is not your type of gas supply, **DO NOT INSTALL THE SYSTEM.** Contact your dealer for the proper model.

All gas piping must be installed to comply with local and national fuel gas codes. Do not use flexible hose unless it is allowed by local codes. Compounds used on threaded joints of gas piping must be resistant to the action of LP gas.

The gas supply line to the fireplace should not be less than 1/2" inside dimension.

The gas supply must be of sufficient size to provide a minimum natural gas pressure of 7 inches water column for natural gas or 11 inches for L.P. gas. The maximum inlet gas pressure to the appliance must not exceed 10 inches for natural gas and 13 inches for L.P. gas. If this appliance is to be supplied with L.P. gas the tank or bottle supplying the gas must have a regulator that reduces gas pressure between 11 and 13 inches water column.

Include a manual shutoff valve and union in the line so the appliance may be disconnected for servicing. Provide a 1/8" NPT plugged tapping for pressure gauge connection between shutoff valve and the appliance.

Test for leaks using soap and water solution after completing the connection. **DO NOT USE OPEN FLAME!**

WARNING: The appliance and its individual shutoff valve must be disconnected from the gas supply piping system during any pressure testing of that system at test pressures in excess of 1/2 psig (3.5kPa). The appliance must be isolated from the gas supply piping system by closing its individual manual shutoff valve during any pressure testing of the gas supply piping system at test pressures equal to or less than 1/2 psig. Pressures in excess of 1/2 psig will cause damage to the unit.

Fireplace Clearances

To guarantee safe installation into a noncombustible fireplace, certain space requirements must be fulfilled.

1. The clearance from the side of the unit to any combustible wall should not be less than 15 1/2 inches.
2. The clearance from the ceiling to the top of the fireplace opening should not be less than 42 inches.
3. The minimum clearance to combustible items in front of the heater is 36 inches.
4. For any fireplace in which this unit is installed, there are certain mantel clearance requirements that must be met.

Minimum Mantel Clearance

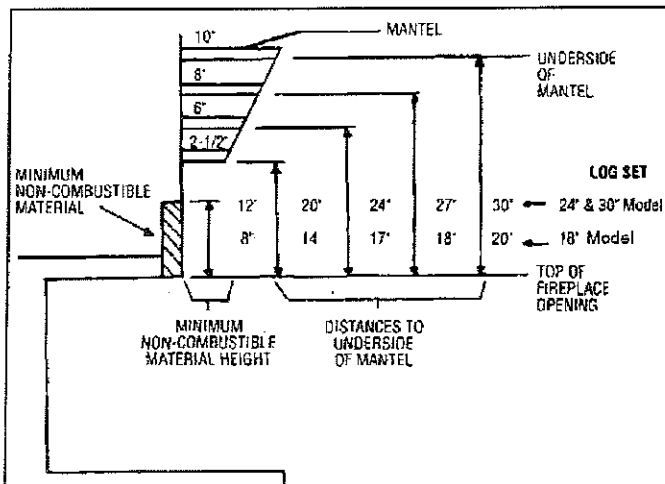

Minimum Mantel Clearance with Canopy

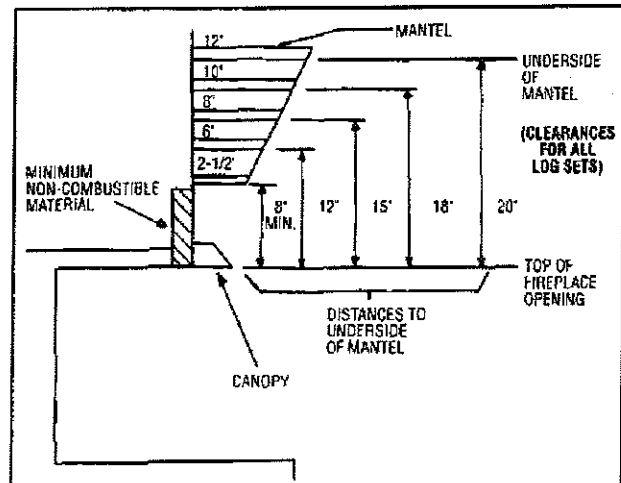

You must have non combustible material(s) above the fireplace opening. Non combustible materials (such as slate, marble, tile, etc.) must be at least 1/2 inch thick. Some decorative fireplace surrounds (cultured marble) may get discolored from the heat produced by the system. With sheet metal, you must have noncombustible material behind it. If noncombustible material is less than 8" you must install fireplace canopy (Model AMG-100).

Burner Assembly Installation

1. Place your grate/burner assembly in the center of your fireplace.
2. Remove the black iron pipe cap from your gas supply pipe.
NOTE: Hold the gas supply pipe securely with a wrench to prevent it from rotating loose and unthreading from the inner wall connection.
3. Tighten the 1/2" NPT by 3/8" flare fitting on the 1/2" gas supply line using pipe joint compound.
4. Fasten the aluminum tube from the gas supply to the gas inlet at the rear of the heater assembly.
NOTE: The use of a flexible hose to attach the gas supply to the burner assembly may cause the burner to make excess noise.

Grate Enhancer Assembly

1. Attach the feet to the bottom of the Grate Enhancer with the screws provided. (See Fig. A)
2. Attach assembled Grate Enhancer to the front part of the Burner System centering it from left to right. (See Fig. B)

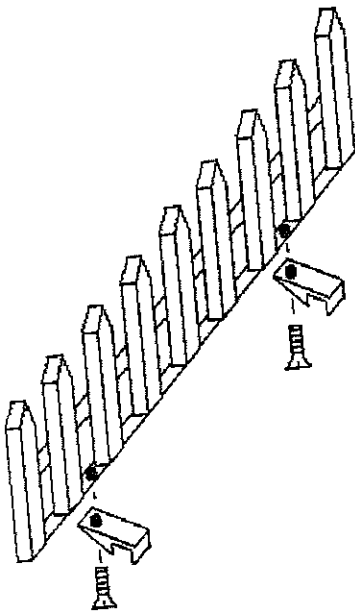

Fig. A Grate Enhancer Assembly

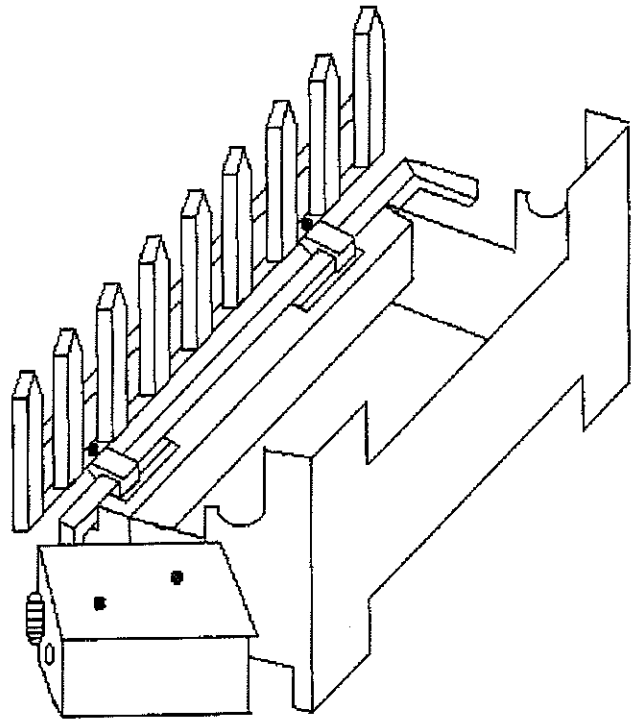
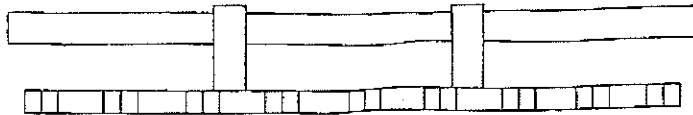
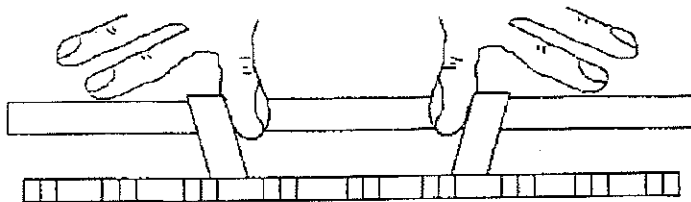

Fig. B Attach Grate Enhancer to the front part of the burner system.

1. Place the Grate Enhancer on the front of the Vent Free frame.



2. Spread the feet of the Grate Enhancer to secure it to the front of the frame.



Log Placement

1. The largest log is placed in the front part of the grate with the notches facing upwards (see Figure 1).
2. The second largest log is placed in the back part of the grate with the notches facing upwards (see Figure 2).
3. Place top logs as shown in illustration pertaining to the set you purchased. Incorrect log placement can lead to the production of harmful carbon monoxide while the unit is in operation. Be sure that the logs are correctly placed in the notches provided for them. There should be no direct impingement of flames on any of the logos.

WARNING: Failure to position the parts specifically approved with this heater may result in property damage or personal injury.

Model RVT-18

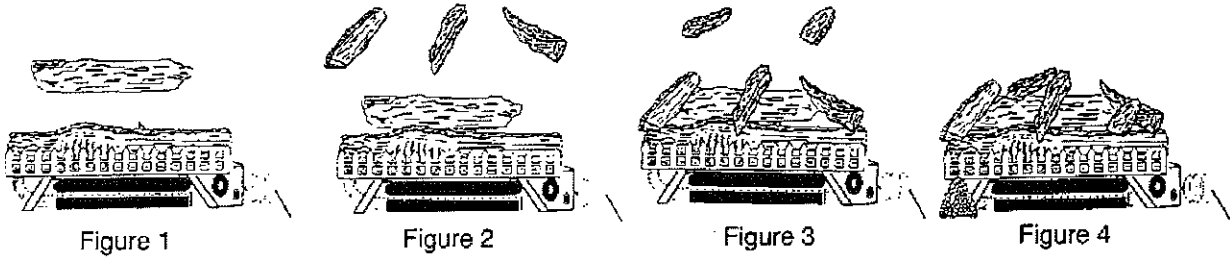

Model RVT-24 and RVT-30

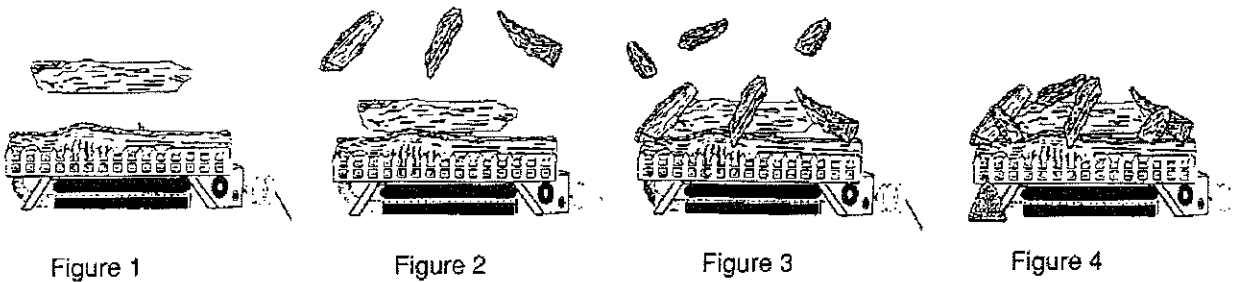

Model GVT-18

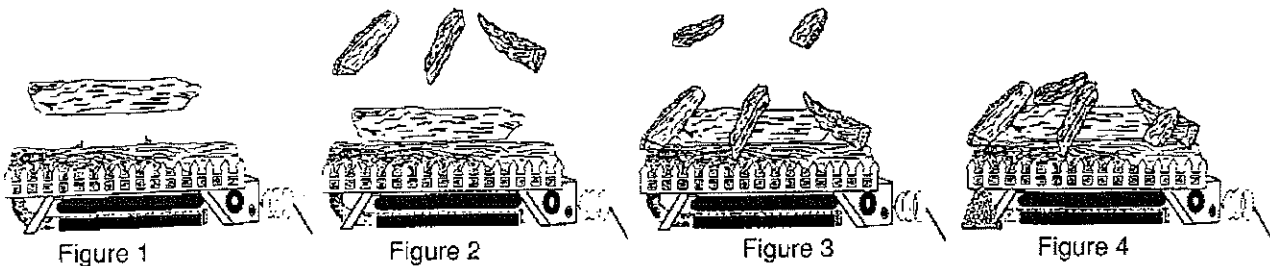

Model GVT-24 and GVT-30

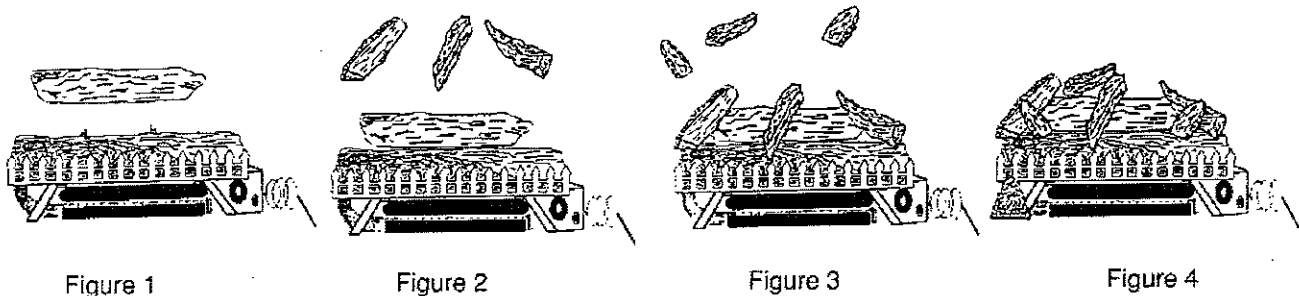

Model VFT-18 and SVT-18

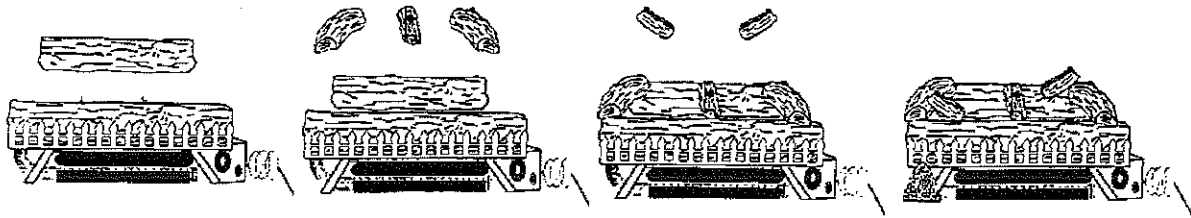

Figure 1

Figure 2

Figure 3

Figure 4

Model VFT-24, SVT-24, VFT-30 and SVT-30

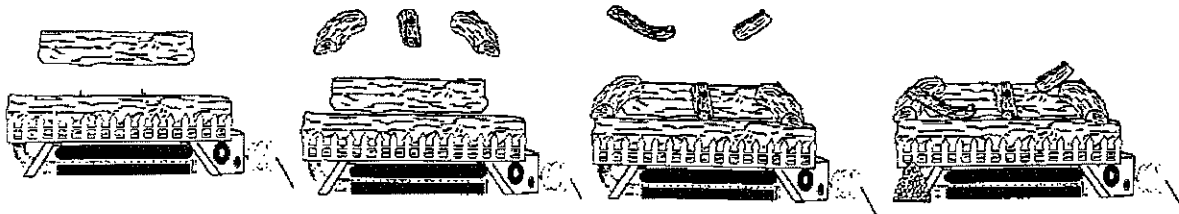

Figure 1

Figure 2

Figure 3

Figure 4

Model CVT-18

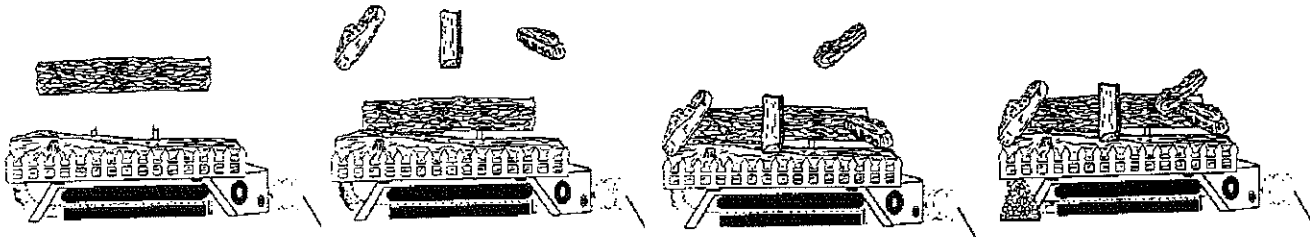

Figure 1

Figure 2

Figure 3

Figure 4

Model CVT-24 and CVT-30

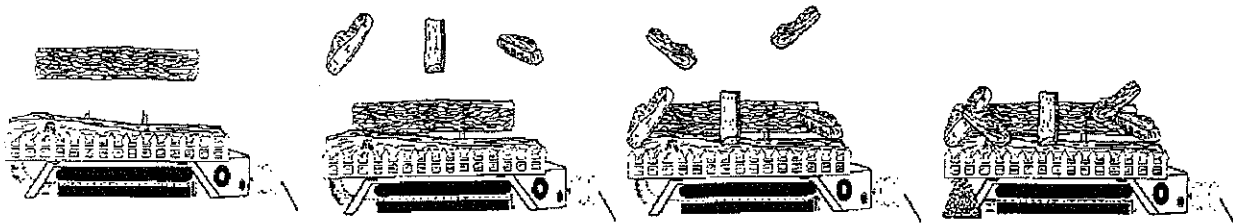

Figure 1

Figure 2

Figure 3

Figure 4

Decorative Volcanic Ash

The volcanic ash (granules) from the bag provided should be spread on the bottom of the fireplace. The volcanic ash should not be placed on or near the burner. Contact with the burner can cause the production of carbon monoxide.

Final Checkpoints Before Operation

1. Before setting the logs in place, turn the gas on and check each joint in the gas line with a soap and water solution for leaks. Bubbles indicate leaks. Repair any leaks and recheck before proceeding.

DANGER: DO NOT USE OPEN FLAME TO TEST FOR LEAKS!

2. It is most convenient to light the pilot and check the operation of the burner without the logs in place. After the final check of the gas supply is complete and the corrections are made, go to the "Lighting Operation" section of this manual. Be sure you follow the instructions for the model you have purchased.
3. After the pilot flame is established, turn the control knob to the "ON" position. The burner should ignite within four (4) seconds. If the burner does not ignite within four (4) seconds, turn valve to OFF position.
4. With the pilot and burner in operation, check each connection with soap and water solution again for leaks. If any leaks are found, turn gas supply off and correct them immediately.
5. After the gas connections are secure, turn control knob to OFF position. Allow system to cool down.
6. Set the front log, the longest log, in position centered side to side on the front part of the grate with the thin flat surface of the log on the grate.
7. Set the back log, the second longest log, in position centered side to side on the back supporting brackets with the thin flat surface of the log on the grate.
8. The top logs should be positioned according to the notches left available by the two bottom logs. See Figures 2 through 4 on page 6 and 7 for top log placement. Be sure to follow the illustrations that pertain to your particular unit.
9. If you are installing a thermostat controlled unit, Model RVT, GVT, VFT, CVT or SVT, and your unit is shutting down, it may be necessary to relocate the thermostat bulb to a cooler location.

FOR YOUR SAFETY READ BEFORE LIGHTING

WARNING: If you do not follow these instructions exactly, a fire or explosion may result causing property damage, personal injury or loss of life.

- A. This appliance is equipped with an ignition device (piezo) which lights the pilot automatically. If the piezo fails to light the pilot, turn to "Match Lighting" Instructions on page 9.

PIEZO

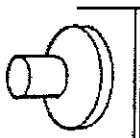

- B. BEFORE LIGHTING the unit, smell around the appliance area for gas. Be sure to smell next to the floor because some gas is heavier than air and will settle on the floor.

WHAT TO DO IF YOU SMELL GAS:

- Do not try to light any appliance.
- Do not touch any electrical switch.
- Do not use any telephone in your building.
- Immediately call your gas supplier from a neighbor's telephone.
- Follow the gas supplier's instructions.
- If you cannot reach your gas supplier, call the fire department.
- Installation and service must be performed by a qualified installer, service agency or the gas supplier.

- C. Use only your hand to push in or turn the gas control knob. Never use tools. If the knob will not push in or turn by hand, do not try to repair. Call a qualified service technician.

WARNING: THE USE OF FORCE OR ATTEMPTED REPAIR MAY RESULT IN A FIRE OR EXPLOSION.

- D. Do not use this appliance if any part has been under water. Immediately call a qualified service technician to inspect the appliance and replace any part of the control system and any gas control which has been under water.

LIGHTING INSTRUCTIONS FOR THERMOSTAT CONTROLLED SYSTEM

Model RVT, GVT, VFT, CVT or SVT

1. STOP! Read the safety information on the previous page before proceeding.
2. Push and turn the control knob clockwise (↻) to OFF. It is necessary to push the knob in before turning to any position.

CONTROL KNOB

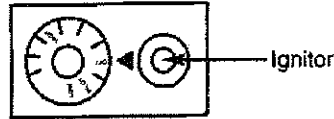

3. Wait five (5) minutes to clear out any gas. If you then smell gas, STOP! Follow "B" in the safety information on page 8. If you do not smell gas, go to the next step.
4. Remove the back and top logs to gain access to the pilot. It is located toward the back of the unit on the right hand side.
5. Push and turn the knob counterclockwise (↺) to PILOT. The word pilot should line up with the ignitor to ensure that you are in the correct position.
6. Position yourself so the pilot can be seen. Push the knob inward fully and hold it in. Immediately push the piezo ignitor button several times. This will cause a spark at the pilot which will ignite the pilot gas. If the pilot does not light immediately, push the ignitor button again, at five (5) second intervals, until the pilot is lit. After the pilot is lit, continue to hold the control knob in for about one (1) minute while the probe warms up. Release the knob and it will pop back out. The pilot should remain lit. If it goes out repeat steps 2 through 6.

MATCH LIGHTING

If the pilot cannot be ignited with the piezo, it can be manually lit with a match. Follow steps 2 through 5. Push the knob in fully and hold it in. Immediately light the pilot with a match. Continue to hold the knob in for about one (1) minute. After one (1) minute, release the knob and it will pop back out. The pilot should remain lit. If it goes out, repeat steps 2 through 6.

- If the control knob does not pop out when released, STOP and immediately call your service technician or gas supplier.
- If the pilot will not stay lit after several tries, turn the gas control knob clockwise (↻) to OFF and call your service technician or gas supplier.

7. Replace the back and top logs in their proper position.
8. Lightly push and turn the knob counterclockwise (↺) to low then all the way to high. (It is not necessary to push the knob in fully when turning the knob to different positions.) Note: The only time the knob should be pushed in completely is when the pilot is to be lit. After one (1) minute adjust the knob between HI or LO as desired.

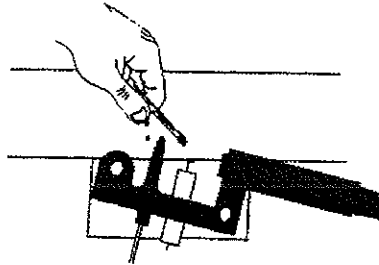

TO TURN GAS OFF TO APPLIANCE

1. Push and turn knob clockwise (↻) to OFF.

Flame Check

A periodic visual check of the flames should be made. The pilot flame should always be present when the appliance is in operation.

The flames should be bluish-yellow in color and should not be impinging on any of the logs.

For your safety, the appliance is equipped with an ODS (oxygen depletion sensor) system. The system senses the oxygen in the atmosphere and switches off the gas supply in case the oxygen falls below a safe level.

RVT, GVT, VFT, CVT & SVT FLAME CHARACTERISTICS

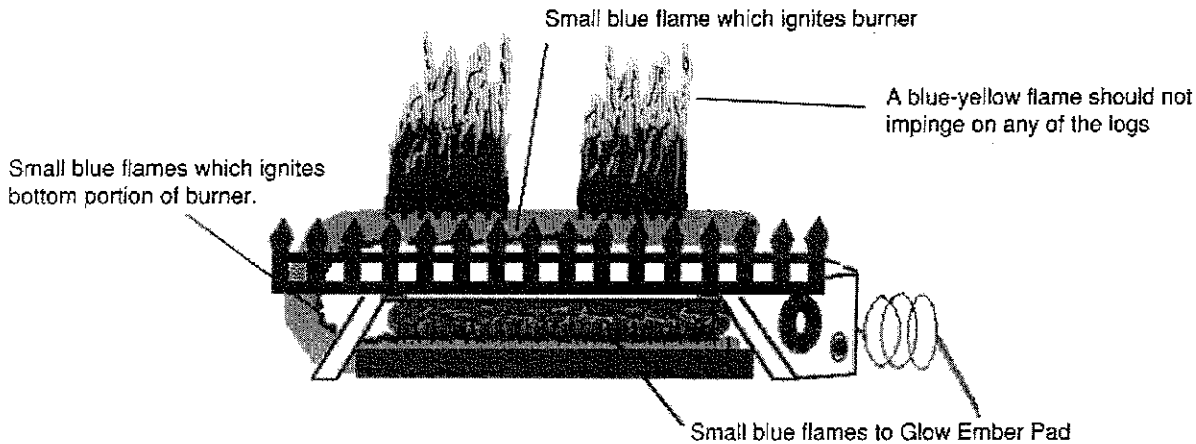

FINAL CHECKS

Things To Do

1. Use only the type of gas for which your system is designed. The type of gas the system is equipped for is stamped on the rating plate.
2. Install appliance and all gas piping according to local codes.
3. Disconnect or isolate the system during line pressure testing.
4. Make sure 1/2" gas line is run to the fireplace to ensure sufficient gas volume to the appliance.
5. Install the system only in a fireplace suitable for burning solid fuel.
6. Use pipe dope on threaded joints of gas piping that is resistant to the action of LP gas.
7. Install a manual shutoff valve, union and 1/8" NPT plugged pressure tap ahead of controls.
8. Use soap and water solution when checking for leaks.
9. Keep the area around the appliance clear and free of combustible materials, gasoline and any flammable or explosive material.
10. Follow the lighting and operation procedures given in this manual.
11. Periodically inspected the pilot and burner flame.
12. Clean the appliance as described in this manual.
13. Keep the logs properly positioned.

Things NOT To Do

1. Do not modify or alter this appliance in any way.
2. Do not use this appliance with any gas other than that for which it is equipped.
3. Do not install this appliance in any area where gasoline or any flammable material is used or stored.
4. Do not use open flame to check for leaks.
5. Do not operate this system with glass doors in the closed position.
6. Do not block or restrict any grilles of a factory built fireplace in which this appliance is installed.
7. Do not burn solid fuels in a fireplace where this appliance is installed.

Maintenance of the System

Under normal use this appliance will require only limited cleaning. Constant air flow through this appliance will cause dust to collect on the burners, base and logs. An excessive build-up of dust can cause the pilot and burners to operate incorrectly and produce high levels of carbon monoxide, a poisonous gas. This unit should be cleaned about once a month.

To clean the burner and base, turn the control to OFF and allow the system to cool down. Remove top logs and front log very carefully. Vacuum or brush away all dust and lint from the system. Do not use any cleaning fluids to clean the logs or any other part of the appliance.

Replace the logs in their proper position and relight the pilot. At least once a year, the log set and all gas piping should be inspected by a qualified service person.

WARNING

When used without fresh air, appliance may give off **carbon monoxide**, an odorless, poisonous gas.

OPEN WINDOW AN INCH OR TWO FOR FRESH AIR WHEN USING APPLIANCE.

This appliance has a **Pilot Light Safety System** that turns the appliance off if enough fresh air is not available.

DO NOT TAMPER WITH PILOT LIGHT SAFETY SYSTEM!

If appliance shuts off, do not relight until you provide fresh air. If appliance continues to shut off, have it serviced by a qualified technician. Keep burner and control compartment clean.

CARBON MONOXIDE POISONING MAY LEAD TO DEATH.

Early signs of carbon monoxide poisoning resemble the flu, with headache, dizziness and/or nausea. If you experience any of these symptoms, appliance may not be working properly. **Get fresh air at once!** Have appliance serviced by a qualified service technician.

Some individuals, pregnant women, persons with heart or lung disorders, anemia, those under the influence of alcohol or those at high altitudes are more likely to be affected by carbon monoxide than others.

Due to high temperatures, this appliance must be located out of traffic and away from furniture and draperies.

Adults and especially children should be alerted to the hazard of high surface temperatures and should be kept away to avoid burns or clothing ignition.

Young children should be carefully supervised when in the same room as the appliance.

Any safety screen or guard removed for servicing the appliance must be replaced prior to operating the appliance.

Do not place clothing or other flammable material on or near appliance.

Installation and repair should only be performed by a qualified service technician.

The appliance should be inspected before use and at least once a year by a qualified service technician.

More frequent cleaning may be required due to excessive lint from some carpeting, bedding or other materials. It is imperative that control compartments, burners and circulating air passageways of this appliance be kept clean.

WARNING: Do not allow fans to blow directly into the fireplace. Avoid any drafts that alter burner flame patterns.

WARNING: Do not use a blower insert, heat exchanger insert or other accessories not approved for use with this heater.

WARNING: Any change to this appliance or its controls can be dangerous.

Parts List

18", 24" & 30" Log System			18", 24" & 30" Log System			18" Log Quantities	
Ref. #	Part Name - VFT,GVT,RVT,SVT, & CVT	Qty.	Ref. #	Part Name - VFT,GVT,RVT,SVT, & CVT	Qty.	Model	No. of Logs
1	Thermocouple	1	15	Tubing-3/8" O.D.	1	RVT	7
2	Electrode	1	16	Fitting-3/8" Female Comp. Elbow	1	GVT	7
3	ODS Pilot System	1	17	Fitting-3/8" x 3/16" Reducer	1	VFT	7
4	16" Wire	1	18	Fitting-3/16" Tee	1	CVT	6
5	3/16" Compression Fitting	1	19	Fitting-Plug (Pressure Tap)	1	SVT	7
6	Tubing 3/16" O.D.	1	20	Orifice	1	24" & 30" Log Quantities	
7	Compression Nut	1	21	Washer	1		
8	Compression Sleeve	1	22	Grate Assembly	1	RVT	8
9	Fitting - 3/8" Male Union	1	23	Burner System	1	GVT	8
10	Piezo Starter	1	24	Decorative Stone	1	VFT	7
11	Main Regulator	1	25	Ember Pad	1	CVT	7
12	Pipe Nipple	1	26	Grate Enhancer	1	SVT	7
13	Control Valve	1	27	Grate Enhancer Screws	2		
14	Fitting-3/8" Compression Elbow	1	28	Grate Enhancer Feet	2		

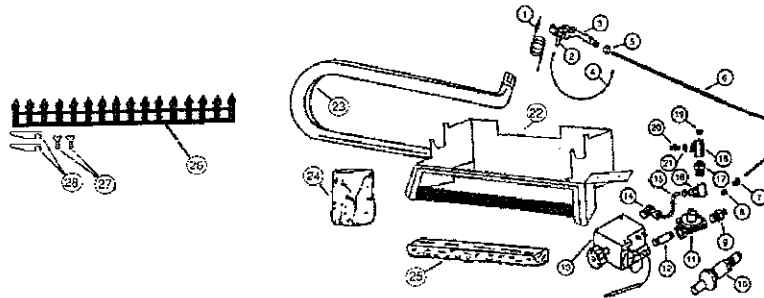

LIMITED LIFETIME WARRANTY

Limited Lifetime Warranty shall apply to the original purchaser at the original installation point only.

All logs are guaranteed for the lifetime of the original purchaser against destruction by fire or heat.

The burner assembly system is guaranteed for a period of three (3) years from the date of purchase and will be replaced for freight costs only.

General Warranty: This warranty does not apply in the case of improper installation, neglect, accident, misuse or as a result of modifications of the original product.

All costs for removal and reinstallation are the expressed responsibility of the purchaser.

Repair, replacement, or service to defective part or parts to be secured at outlet of original purchase within first 30 days of purchase. Thereafter, with valid warranty registration and proof of purchase, ship defective part prepaid and insured in original carton to Sure Heat Manufacturing, 3130 Moon Station Road, Kennesaw, GA 30144. Goods returned improperly packaged are the sole responsibility of purchaser.

It is agreed that any repair or replacement is the exclusive remedy from Sure Heat Manufacturing. In no case shall Sure Heat be liable for any consequential damage for breach of this or any other warranty expressed or implied whatsoever. This limitation as to consequential damages shall not apply in states where prohibited.

Purchased From: _____ Date: _____

Size: 18" 24" 30" Model: _____

Name _____ Phone (____) _____

Address _____

City _____ State _____ Zip _____

Please photocopy and return to Sure Heat within 14 days of purchase

If you have other questions, please contact Customer Service Hotline
(770) 422-8008

copreci
R84010 Rev. 3/00